



TERMINAL

2.0mm Battery Female Connector

SPECIFICATIONS



Current Rating: 5.0AMP
 Contact Resistance: 30mΩ Max.
 Insulation Resistance: 100MΩ Min.
 Withstanding Voltage : 500V AC/Minute
 Operation Temperature: -40°C to +85°C
 Contact Material: Phosphor Bronze
 Contact plating: Au or Tin Over Ni
 Insulator Material: Polyester (UL94V-0)
 Standard: PA6T+30%GF

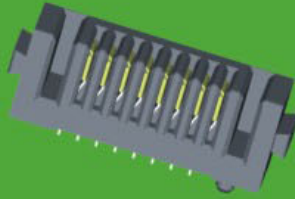
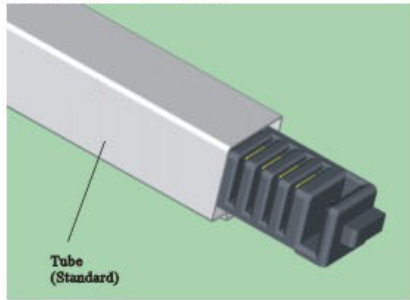

4110FXXN01DXX01



4110FXXN01DXX02

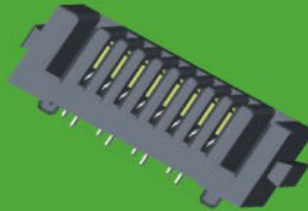

4110FXXN01DXX03

4110 F XX N 01 D XX 0 X

NO. OF PIN
5~9PIN

CONTACT PLATING	
G0:1u" Gold	S0:1u" Gold/Tin
G1:3u" Gold	S1:3u" Gold/Tin
G2:5u" Gold	S2:5u" Gold/Tin
G3:10u"Gold	S3:10u"Gold/Tin
G4:15u"Gold	S4:15u"Gold/Tin
G5:30u"Gold	S5:30u"Gold/Tin
G6:20u"Gold	S6:20u"Gold/Tin
	SN:Tin

JOURNAL NUMBER
 1:Type A
 2:Type B
 3:Type C

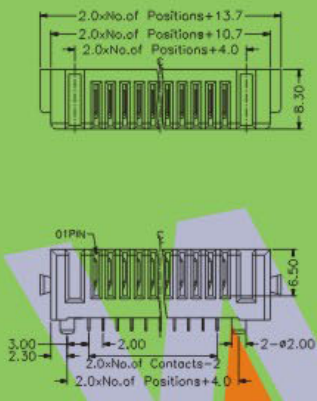

PART NO.	TYPE
4110-FXXN01DXX01	TYPE A
4110-FXXN01DXX02	TYPE B
4110-FXXN01DXX03	TYPE C

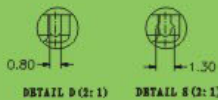
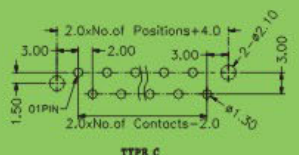
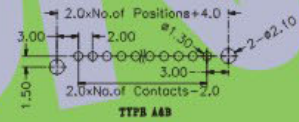
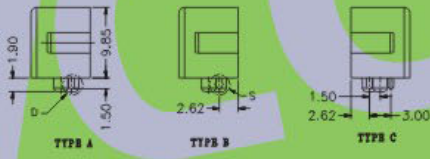

Recommended P. C. B Layout (Top Side)

※ INNOVATION AND DEVELOPMENT ※ CONTINUAL IMPROVEMENT ※ QUALITY FOREMOST ※ CUSTOMER SATISFACTION ※

Http:www.wafe-china.com E-mail:sales@wafe-china.com

WAFE DONGGUAN FAX:+86 769 85358915 TEL:+86 769 85358920
 WAFE KUNSHAN FAX:+86 512 57468468 TEL:+86 512 57468418